



Opto Plus LED Corp
OPS-L0638LEC
Side View PLCC LED

● **EDIT HISTORY**

Version A : Aug. 08, 2022

Preliminary Spec.

Confidential Document

● FEATURES

- 0.6 x 3.8 x 1.0 Side View PLCC LED
- Wide viewing angle.
- Low power consumption.
- RoHS compliant.

● PACKAGE DIMENSIONS

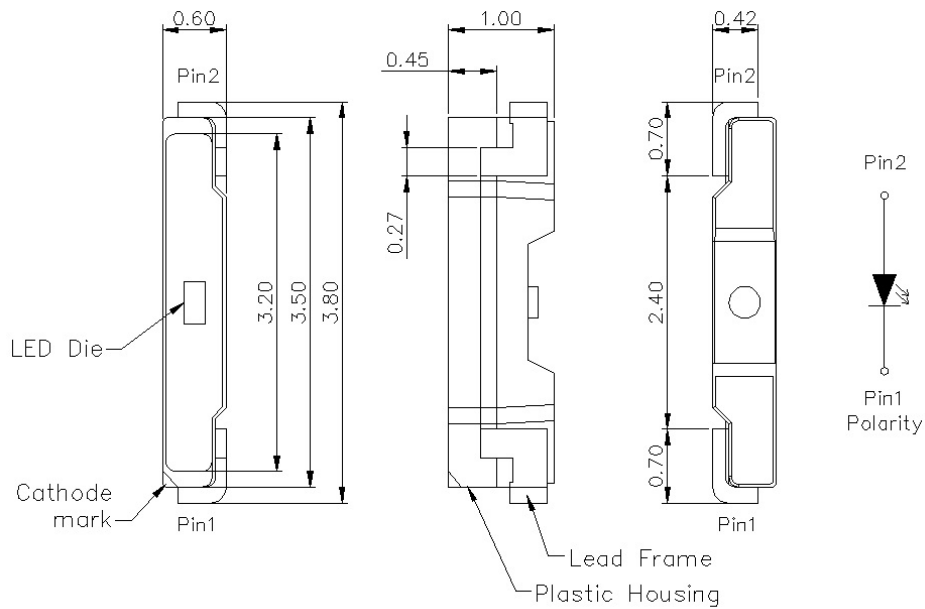

● SOLDERING PATTERN

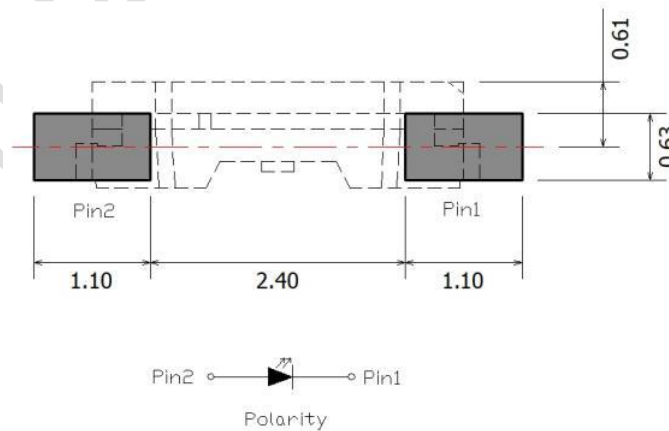

Unit:mm Tolerance: +/-0.05



Opto Plus LED Corp
OPS-L0638LEC
 Side View PLCC LED

● **LE: SUPER BRIGHT RED (AlGaInP/GaAs)**

ABSOLUTE MAXIMUM RATING AT Ta=25°C

Parameter	Symbol	Maximum Rating	Unit
Power dissipation per SMD	P _{AD}	52	mW
Continuous forward current per SMD	I _{AF}	20	mA
Peak current per dice (duty cycle 1/10, 1kHz)	I _{PF}	30	mA
Reverse voltage per SMD	V _R	5	V
Operating temperature	T _{OPR}	-40 to +85	°C
Storage temperature	T _{STG}	-40 to +100	°C

ELECTRICAL - OPTICAL CHARACTERISTICS AT Ta=25°C

Characteristic	Symbol	Condition	Min.	Typ.	Max.	Unit
Forward voltage	V _F	I _F =20mA	-	2.1	2.6	V
Reverse current	I _R	V _R =5V	-	-	10	μA
Peak wavelength	λ _P	I _F =20mA	-	630	-	nm
Dominant wavelength	λ _D	I _F =20mA	-	623	-	nm
Luminous intensity	I _V	I _F =20mA	-	900	-	mcd
Spectral radiation bandwidth	Δλ	I _F =20mA	-	20	-	nm
Viewing Angle	2θ _{1/2}	I _F =20mA	-	120	-	deg



Opto Plus LED Corp
OPS-L0638LEC
Side View PLCC LED

● **Luminous Intensity (IV) BIN: (mcd)**

Bin Code	X	Y	Z
Spec. Range	715.0~900.0	900.0~1125.0	1125.0~1440.0

Note: It maintains a tolerance of $\pm 10\%$ on Luminous Intensity

● **Dominant Wavelength(Wd) Bin: (nm)**

Bin Code	A	B	C
Spec. Range	615.0~620.0	620.0~625.0	625.0~630.0

Note: It maintains a tolerance of $\pm 0.5\text{nm}$ on Wavelength Bin

● **Forward Voltage (Vf) Bin : (v)**

Bin Code	E1A
Spec. Range	1.6~2.6 V

Note: It maintains a tolerance of $\pm 0.05\text{V}$ on forward voltage measurements

Typical Electro-optical Characteristic Curves (25 °C Free Air Temperature Unless Otherwise Specified)

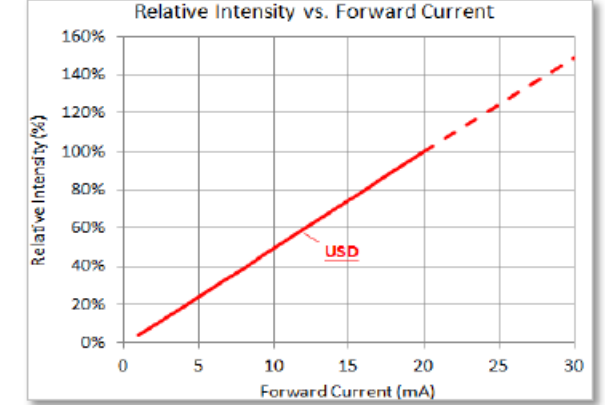
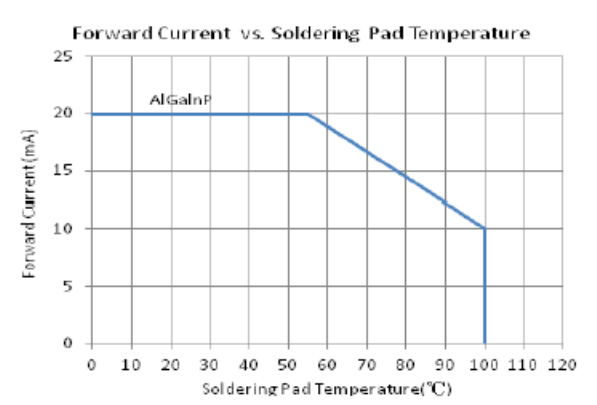
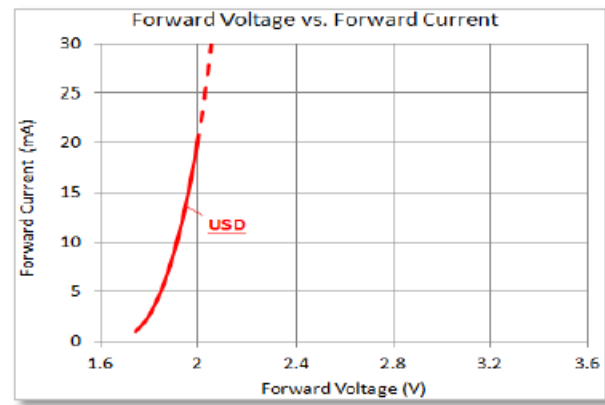
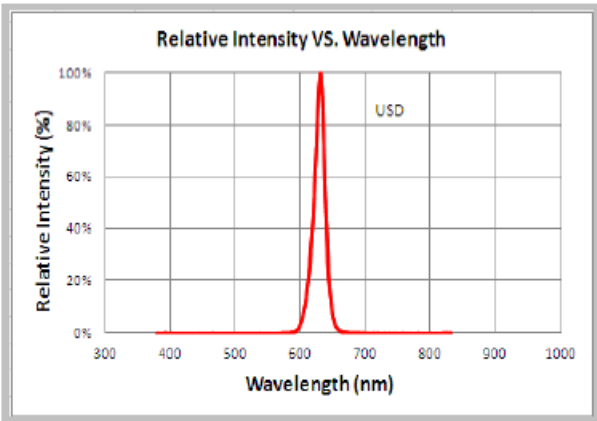

Directive Characteristics

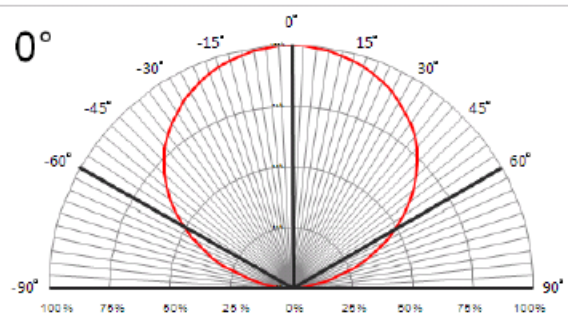
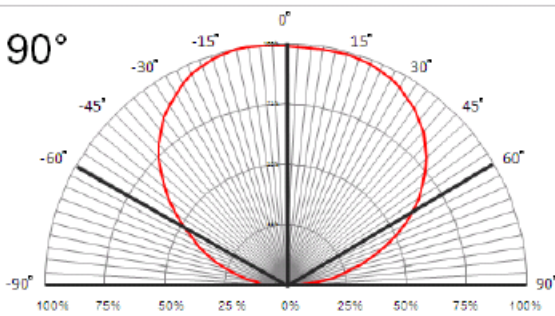

Precaution for Use

- 1.The chips should not be used directly in any type of fluid such as water, oil, organic solvent, etc.
- 2.When the LEDs are illuminating, the maximum ambient temperature should be first considered before operation.
- 3.LEDs must be stored in a clean environment. A sealed container with a nitrogen atmosphere is necessary if the storage period is over 3 months after shipping.
- 4.The LEDs must be used within 72 hrs after unpacked. Unused products must be repacked in an anti-electrostatic package, folded to close any opening and then stored in a dry and cool space.
- 5.The appearance and specifications of the products may be modified for improvement without further notice.
- 6.The LEDs are sensitive to the static electricity and surge. It is strongly recommended to use a grounded wrist band and anti-electrostatic glove when handling the LEDs.If a voltage over the absolute maximum rating is applied to LEDs, it will damage LEDs.Damaged LEDs will show some abnormal characteristics such as remarkable increase of leak current, lower turn-on voltage and getting unlit at low current.

Reel Dimension

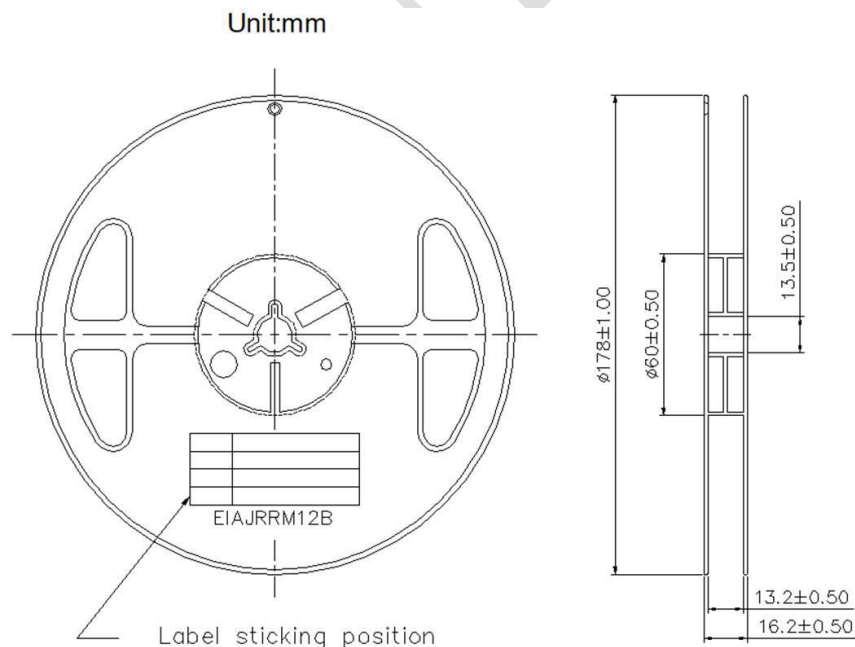

Packaging

Tape Dimension

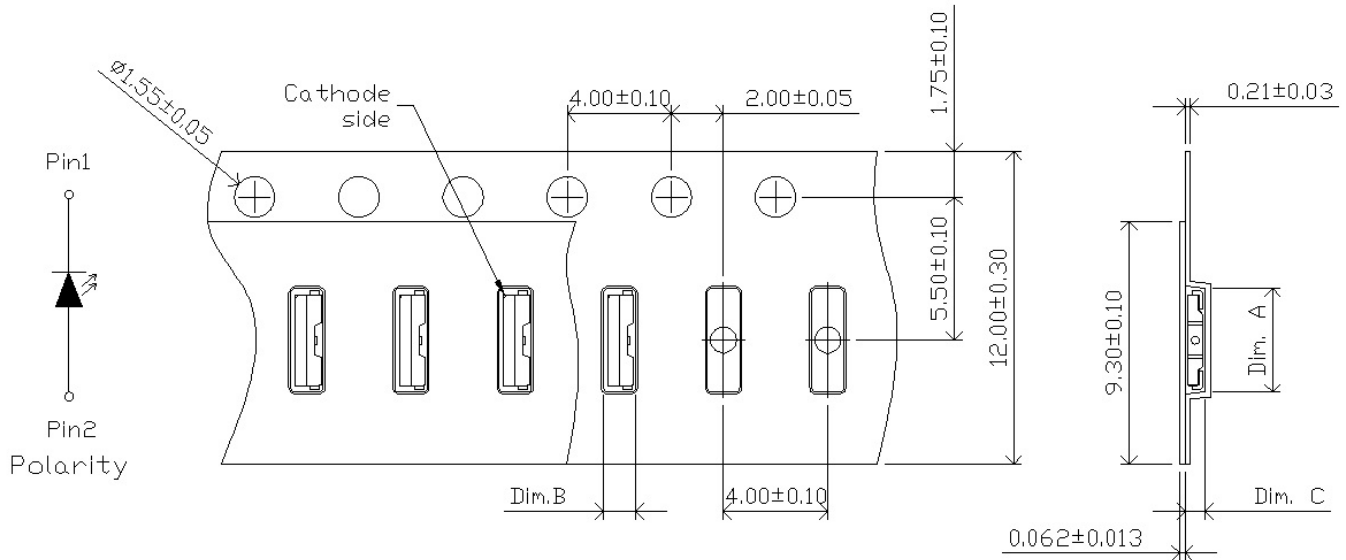

Dim. A	Dim. B	Dim. C	Q'ty/Reel
4.0 ± 0.05	1.25 ± 0.05	0.78 ± 0.05	2K

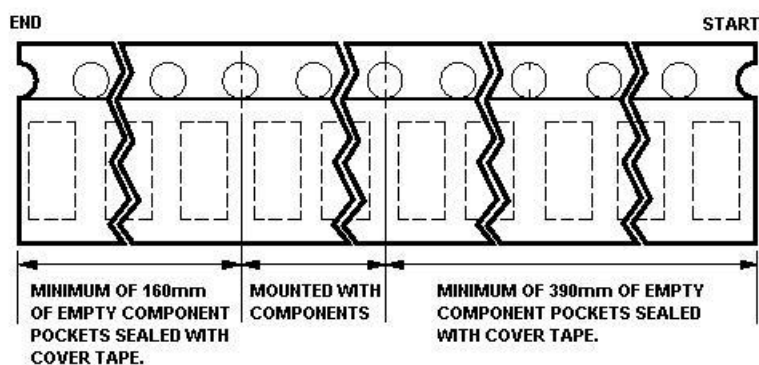



Opto Plus LED Corp

OPS-L0638LEC

Side View PLCC LED

Dry Pack

All SMD optical devices are **MOISTURE SENSITIVE**. Avoid exposure to moisture at all times during transportation or storage. Every reel is packaged in a moisture protected anti-static bag. Each bag is properly sealed prior to shipment.

Upon request, a humidity indicator will be included in the moistureprotected anti-static bag prior to shipment.

The packaging sequence is as follows:

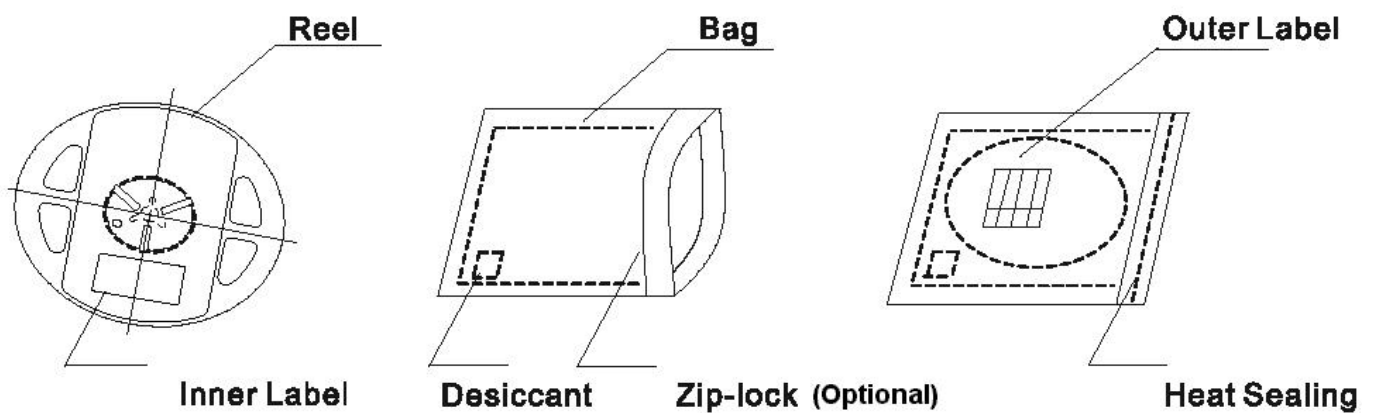

Baking

Baking before soldering is recommended when the package has been unsealed for 4 weeks.

The conditions are as followings:

1. $60\pm 3^{\circ}\text{C} \times (12\sim 24\text{hrs})$ and $< 5\% \text{RH}$, taped reel type.
2. $100\pm 3^{\circ}\text{C} \times (45\text{min}\sim 1\text{hr})$, bulk type.
3. $130\pm 3^{\circ}\text{C} \times (15\text{min}\sim 30\text{min})$, bulk type.

Precautions

1. Avoid exposure to moisture at all times during transportation or storage.
2. Anti-Static precaution must be taken when handling GaN, InGaN, and AlInGaP products.
3. It is suggested to connect the unit with a current limiting resistor of the proper size. Avoid applying a reverse voltage beyond the specified limit.
4. Avoid operation beyond the limits as specified by the absolute maximum ratings.
5. Avoid direct contact with the surface through which the LED emits light.
6. If possible, assemble the unit in a clean room or dust-free environment.

Handling of Silicone Resin LEDs

Handling Indications

During processing, mechanical stress on the surface should be minimized as much as possible. Sharp objects of all types should not be used to pierce the sealing compound.



Figure 1

In general, LEDs should only be handled from the side. By the way, this also applies to LEDs without a silicone sealant, since the surface can also become scratched.

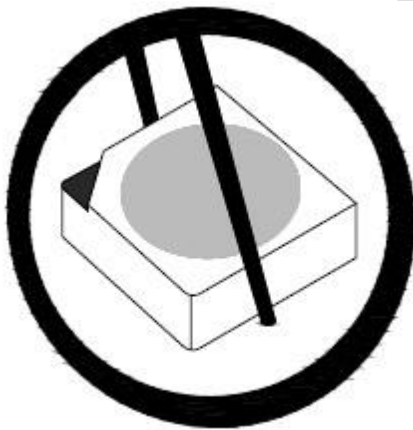

Figure 2

When populating boards in SMT production, there are basically no restrictions regarding the form of the pick and place nozzle, except that mechanical pressure on the surface of the resin must be prevented.

This is assured by choosing a pick and place nozzle which is large than LEDs reflector area.



Opto Plus LED Corp

OPS-L0638LEC

Side View PLCC LED

Reflow Soldering

Recommend soldering paste specifications:

1. Operating temp.: Above 217°C ,60~150 sec.
2. Peak temp.: 260°C Max.,10sec Max.
3. Reflow soldering should not be done more than two times.
4. Never attempt next process until the component is cooled down to room temperature after reflow.
5. The recommended reflow soldering profile (measured on the surface of the LED terminal) is as following:

Lead-free Solder Profile

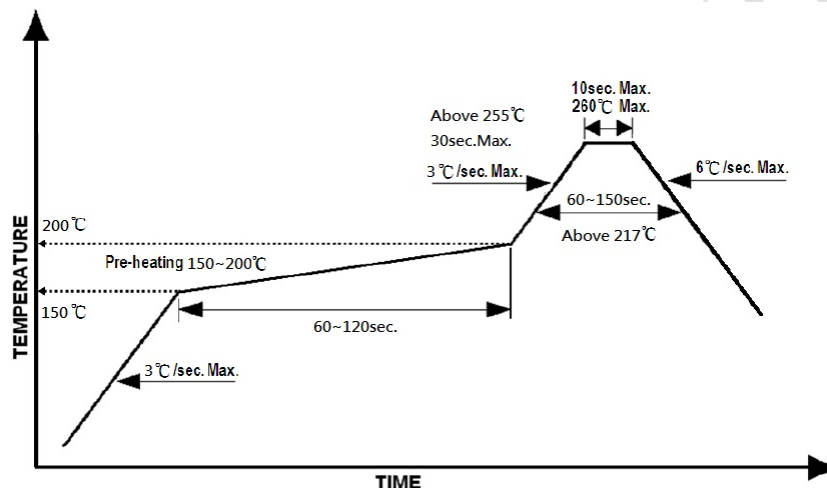

Reworking

- Rework should be completed within 5 seconds under 260°C .
- The iron tip must not come in contact with the copper foil.
- Twin-head type is preferred.

Cleaning

Following are cleaning procedures after soldering:

- An alcohol-based solvent such as isopropyl alcohol (IPA) is recommended.
- Temperature x Time should be $50^{\circ}\text{C} \times 30\text{sec.}$ or $<30^{\circ}\text{C} \times 3\text{min}$
- Ultrasonic cleaning: $< 15\text{W/ bath}$; bath volume $\leq 1\text{liter}$
- Curing: 100°C max, $<3\text{min}$