



**Opto Plus LED Corp.**  
**0.30" Case Mold Type LED Display**  
**OPD-T3010YG | OPD-T3011YG**

● **EDIT HISTORY**

Version A : Nov. 04, 2020

Preliminary Spec.



# Opto Plus LED Corp.

## 0.30" Case Mold Type LED Display

### OPD-T3010YG | OPD-T3011YG

#### ● FEATURES

- 0.30 inch (7.8 mm) Digit Height.
- Low current operation.
- Case mold type.
- RoHS compliant, Pb Free.

#### ● DESCRIPTION

The device are 0.30 inch (7.8 mm) height triple digit 7-segment displays.

The device is Opto Plus LED Corp standard LED Display.

This device utilizes Super Bright Yellow Green LED chip which are made from AlGaInP on a transparent GaAs substrate.

The device has face and segment option, please refer to **PRODUCT APPEARANCE**.

#### ● DEVICE

	PART NO.	DESCRIPTION
	OPD-T3010YG-GW	Common Anode   Gray face   White segment
	OPD-T3011YG-GW	Common Cathode   Gray face   White segment
	OPD-T3010YG-BW	Common Anode   Black face   White segment
	OPD-T3011YG-BW	Common Cathode   Black face   White segment

#### RoHS Compliance



#### Pb Free.



### MECHANICAL DIMENSIONS

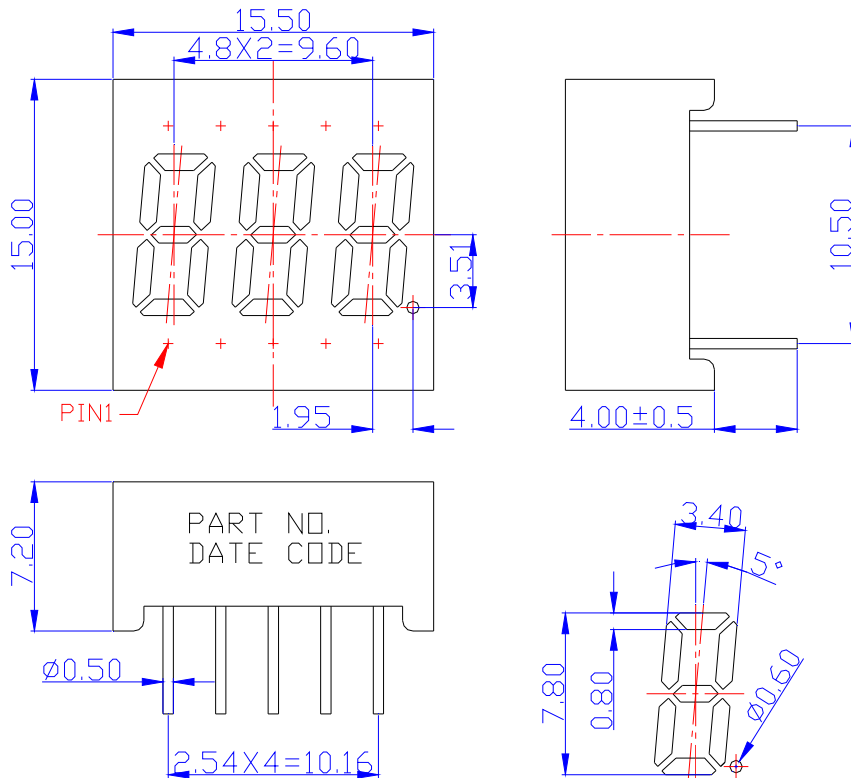

NOTES: Dimension is in millimeters. Tolerance is  $\pm 0.25$  mm unless otherwise noted.

### TYPICAL INTERNAL EQUIVALENT CIRCUIT

Turn On Color

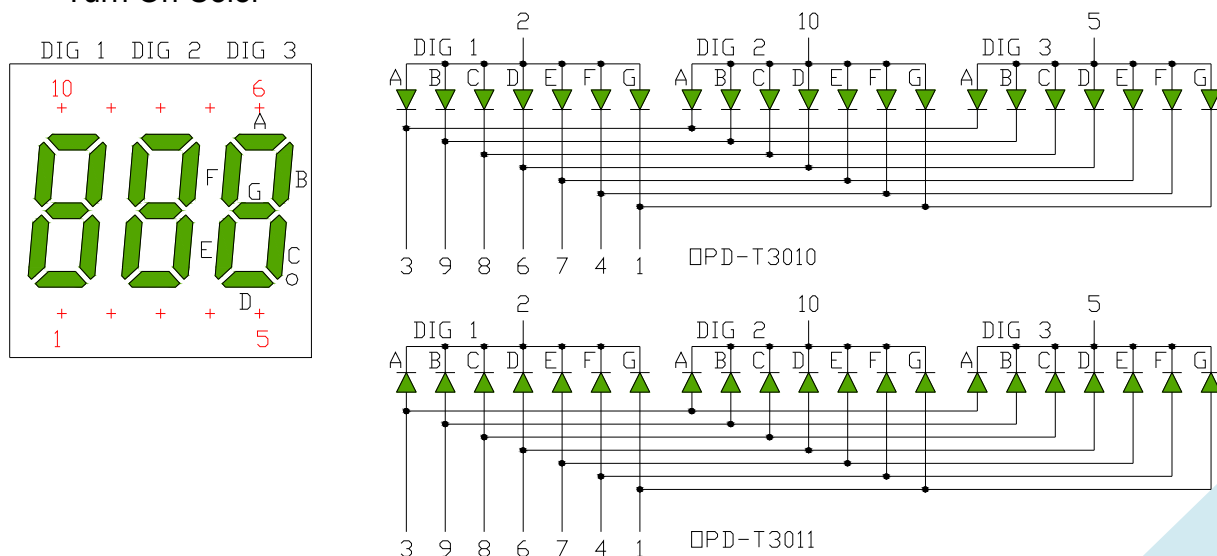

※EMITTED COLOR : SUPER BRIGHT YELLOW GREEN



**Opto Plus LED Corp.**  
**0.30" Case Mold Type LED Display**  
**OPD-T3010YG | OPD-T3011YG**

● **YG: SUPER BRIGHT YELLOW GREEN (AlGaInP/GaAs)**

ABSOLUTE MAXIMUM RATING AT Ta=25°C

Parameter	Symbol	Maximum Rating	Unit
Power dissipation	$P_{AD}$	48	mW
Continuous forward current	$I_{AF}$	20	mA
Peak current (duty cycle 1/10, 1kHz)	$I_{PF}$	40	mA
Reverse voltage	$V_R$	5	V
Operating temperature	$T_{OPR}$	-40 to +85	°C
Storage temperature	$T_{STG}$	-40 to +85	°C

ELECTRICAL - OPTICAL CHARACTERISTICS AT Ta=25°C

Characteristic	Symbol	Condition	Min.	Type.	Max.	Unit
Forward Voltage	$V_F$	$I_F = 20\text{mA}$	-	2.1	2.4	V
Reverse Current	$I_R$	$V_R = 5\text{V}$	-	-	10	$\mu\text{A}$
Peak Wavelength	$\lambda_P$	$I_F = 20\text{mA}$	-	573	-	nm
Dominant Wavelength	$\lambda_D$	$I_F = 20\text{mA}$	567	571	576	nm
Luminous Intensity	$I_V$	$I_F = 20\text{mA}$	-	15	-	mcd
Spectral Line Half-Bandwidth	$\Delta\lambda$	$I_F = 20\text{mA}$	-	20	-	nm



## Opto Plus LED Corp. 0.30" Case Mold Type LED Display OPD-T3010YG | OPD-T3011YG

### ● PRODUCT APPEARANCE

The most common reflector color and segment color are show in below diagram.

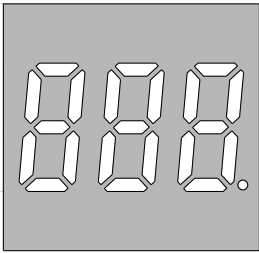
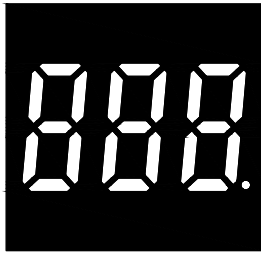
-GW	-BW
	
※ REFLECTOR COLOR: Gray ※ SEGMENT COLOR: White	※ REFLECTOR COLOR: Black ※ SEGMENT COLOR: White

Opto Plus can customize reflector and segment colors by customer's request. If you have these request please visit [www.opledtw.com](http://www.opledtw.com) or contact [sales@opledtw.com](mailto:sales@opledtw.com) for more **Standard Product Customization** information.

Part NO. related to reflector and segment colors show as table below.

PART NO.	DESCRIPTION
OPD-T3010YG-GW	Common Anode   Gray face   White segment
OPD-T3011YG-GW	Common Cathode   Gray face   White segment
OPD-T3010YG-BW	Common Anode   Black face   White segment
OPD-T3011YG-BW	Common Cathode   Black face   White segment



# Opto Plus LED Corp.

## 0.30" Case Mold Type LED Display

### OPD-T3010YG | OPD-T3011YG

#### ● YG: SUPER BRIGHT YELLOW GREEN (AlGaInP/GaAs) CURVE

Typical Electro-optical Characteristic Curves  
(25 °C Free Air Temperature Unless Otherwise Specified)

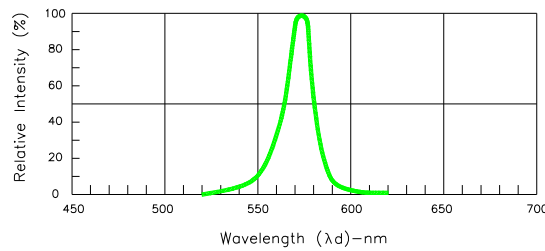

Fig.1-Relative Intensity VS. Wavelength

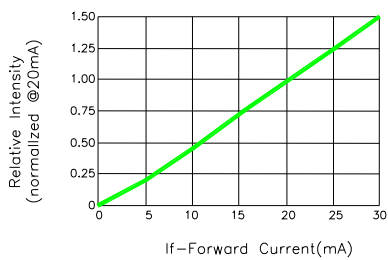

Fig.2-Relative Luminous Intensity vs. Forward Current

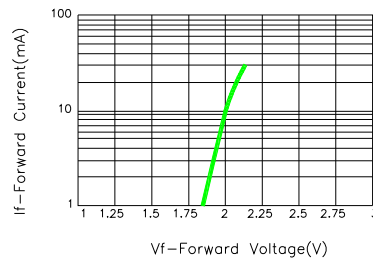

Fig.3-Forward Current vs. Forward Voltage

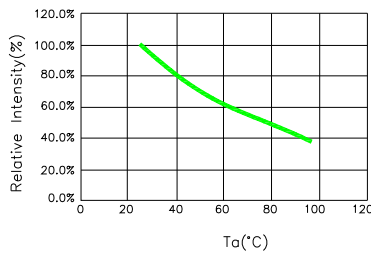

Fig.4-Relative Intensity(@20mA)VS. Ambient Temperature

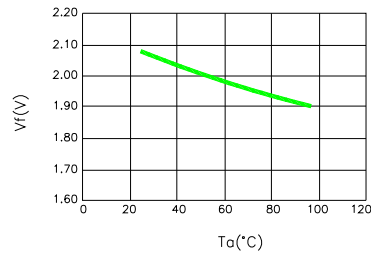

Fig.5-Forward Voltage(@20mA)VS. Ambient Temperature

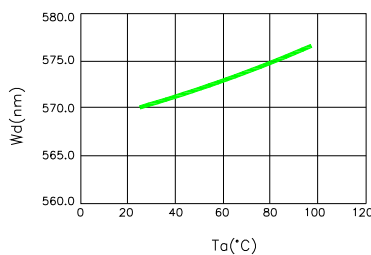

Fig.6-Dominant Wavelength(@20mA) VS. Ambient Temperature

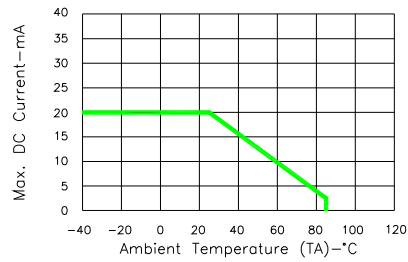

Fig.7-Max. Allowable DC Current VS. Ambient Temperature



# Opto Plus LED Corp.

## 0.30" Case Mold Type LED Display

### OPD-T3010YG | OPD-T3011YG

#### RECOMMEND SOLDERING PROFILE

#### WAVE SOLDER PROFILE

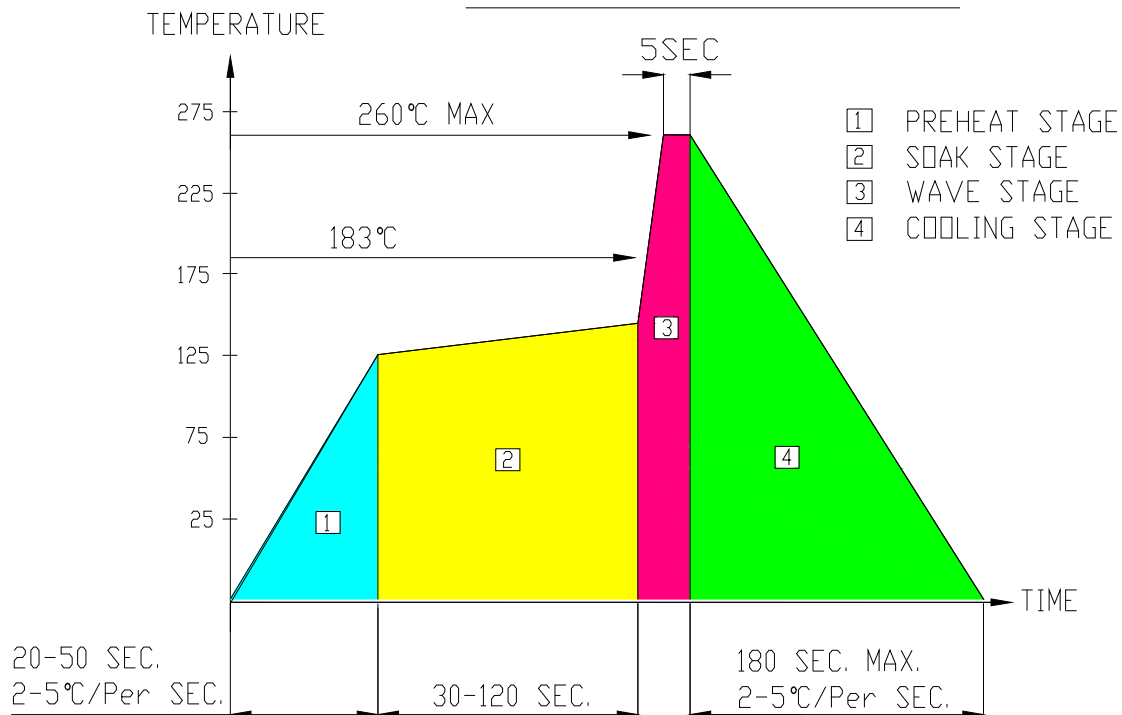

#### Note:

- Recommend pre-heat temperature of 105°C or less (as measured with a thermocouple attached to the LED pins) prior to immersion in the solder wave with a maximum solder bath temperature of 260°C
- Peak wave soldering temperature between 245°C ~ 225°C for 3 sec (5 sec max)
- No more than one wave soldering pass

#### SOLDERING IRON

Basic spec is  $\leq 4$  sec when 260°C. If temperature is higher, time should be shorter (+10°C → 1 sec). Power dissipation of Iron should be smaller than 15W, and temperature should be controllable. Surface temperature of the device should be under 230°C.

#### REWORK

Customer must finish rework within  $\leq 3$  sec under 350°C.  
The head of soldering iron cannot touch copper foil.