

www.opledtw.com

Opto Plus LED Corp.
0.30" Case Mold Type LED Display
OPD-T3010LA | OPD-T3011LA

● **EDIT HISTORY**

Version A: Nov. 04, 2020

Preliminary Spec.



Opto Plus LED Corp.

0.30" Case Mold Type LED Display

OPD-T3010LA | OPD-T3011LA

● FEATURES

- 0.30 inch (7.8 mm) Digit Height.
- Low current operation.
- Case mold type.
- RoHS compliant, Pb Free.

● DESCRIPTION

The device are 0.30 inch (7.8 mm) height triple digit 7-segment displays.

The device is Opto Plus LED Corp standard LED Display.

This device utilizes Super Bright Amber LED chip which are made from AlGaInP on a transparent GaAs, substrate.

The device has face and segment option, please refer to **PRODUCT APPEARANCE**.

● DEVICE

PART NO.	DESCRIPTION
OPD-T3010LA-GW	Common Anode Gray face White segment
OPD-T3011LA-GW	Common Cathode Gray face White segment
OPD-T3010LA-BW	Common Anode Black face White segment
OPD-T3011LA-BW	Common Cathode Black face White segment

RoHS Compliance



Pb Free.



MECHANICAL DIMENSIONS

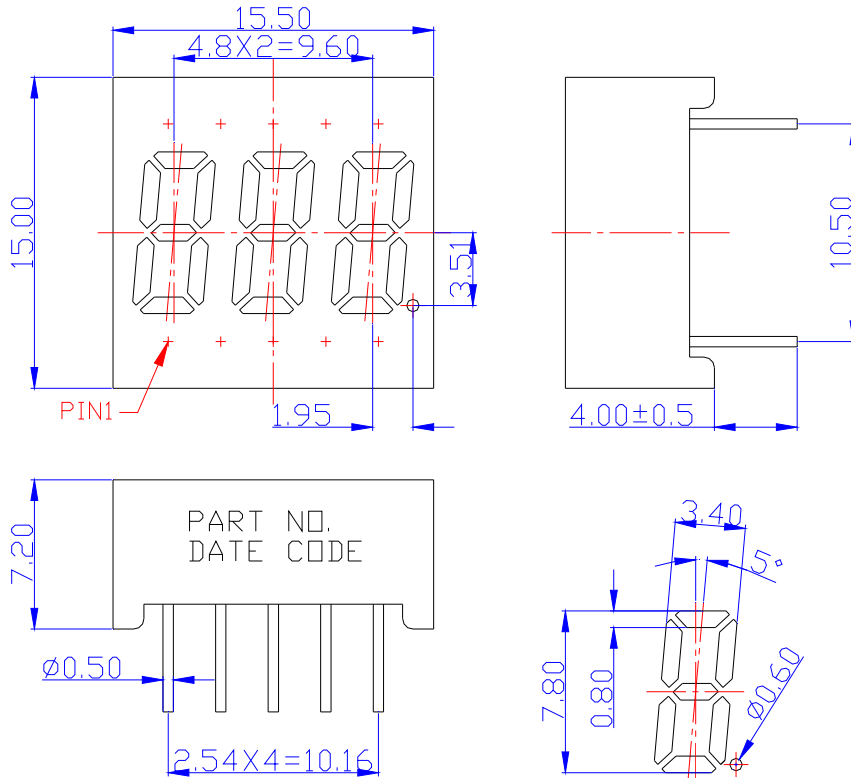

NOTES: Dimension is in millimeters. Tolerance is ± 0.25 mm unless otherwise noted.

TYPICAL INTERNAL EQUIVALENT CIRCUIT

Turn On Color

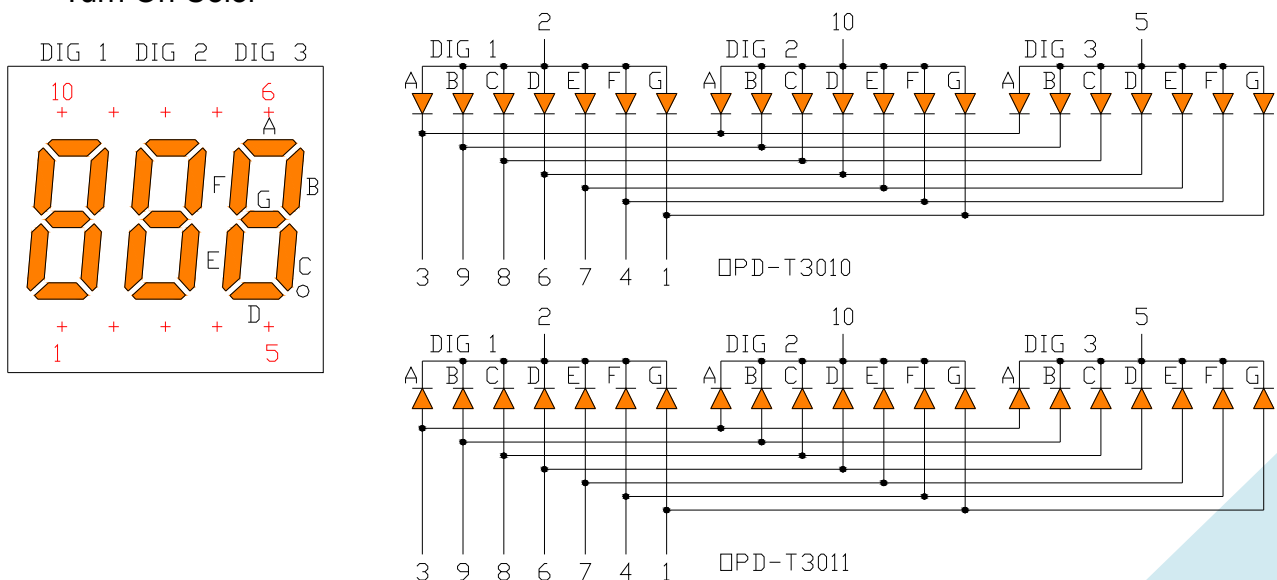

※EMITTED COLOR : SUPER BRIGHT AMBER



Opto Plus LED Corp.

0.30" Case Mold Type LED Display

OPD-T3010LA | OPD-T3011LA

● LA: SUPER BRIGHT AMBER (AlGaInP/GaAs)

ABSOLUTE MAXIMUM RATING AT Ta=25°C

Parameter	Symbol	Maximum Rating	Unit
Power dissipation	P_{AD}	48	mW
Continuous forward current	I_{AF}	20	mA
Peak current (duty cycle 1/10, 1kHz)	I_{PF}	40	mA
Reverse voltage	V_R	5	V
Operating temperature	T_{OPR}	-40 to +85	°C
Storage temperature	T_{STG}	-40 to +85	°C

ELECTRICAL - OPTICAL CHARACTERISTICS AT Ta=25°C

Characteristic	Symbol	Condition	Min.	Type.	Max.	Unit
Forward Voltage	V_F	$I_F = 20\text{mA}$	-	2.0	2.4	V
Reverse Current	I_R	$V_R = 5\text{V}$	-	-	10	μA
Peak Wavelength	λ_P	$I_F = 20\text{mA}$	-	612	-	nm
Dominant Wavelength	λ_D	$I_F = 20\text{mA}$	600	606	610	nm
Luminous Intensity	I_V	$I_F = 20\text{mA}$	-	40	-	mcd
Spectral Line Half-Bandwidth	$\Delta\lambda$	$I_F = 20\text{mA}$	-	20	-	nm



Opto Plus LED Corp.

0.30" Case Mold Type LED Display

OPD-T3010LA | OPD-T3011LA

● PRODUCT APPEARANCE

The most common reflector color and segment color are show in below diagram.

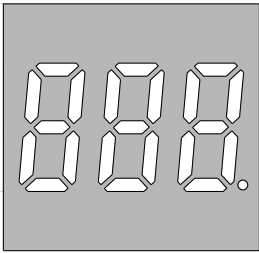
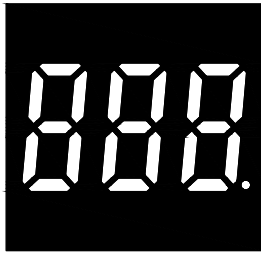
-GW	-BW
	
※ REFLECTOR COLOR: Gray ※ SEGMENT COLOR: White	※ REFLECTOR COLOR: Black ※ SEGMENT COLOR: White

Opto Plus can customize reflector and segment colors by customer's request. If you have these request please visit www.opledtw.com or contact sales@opledtw.com for more **Standard Product Customization** information.

Part NO. related to reflector and segment colors show as table below.

PART NO.	DESCRIPTION
OPD-T3010LA-GW	Common Anode Gray face White segment
OPD-T3011LA-GW	Common Cathode Gray face White segment
OPD-T3010LA-BW	Common Anode Black face White segment
OPD-T3011LA-BW	Common Cathode Black face White segment



Opto Plus LED Corp.

0.30" Case Mold Type LED Display

OPD-T3010LA | OPD-T3011LA

● LA: SUPER BRIGHT AMBER (AlGaInP/GaAs) CURVE

Typical Electro-optical Characteristic Curves
(25 °C Free Air Temperature Unless Otherwise Specified)

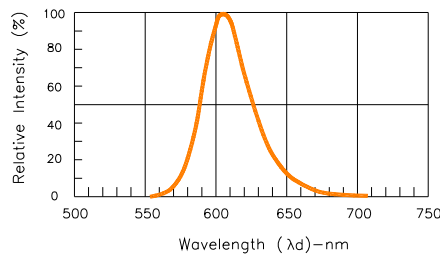

Fig.1-Relative Intensity VS. Wavelength

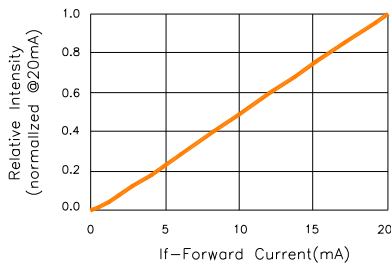

Fig.2-Relative Luminous Intensity vs. Forward Current

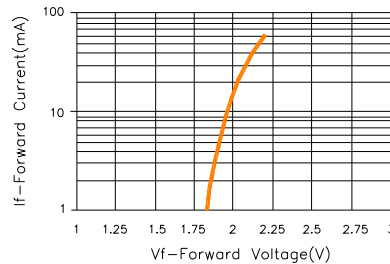

Fig.3-Forward Current vs. Forward Voltage

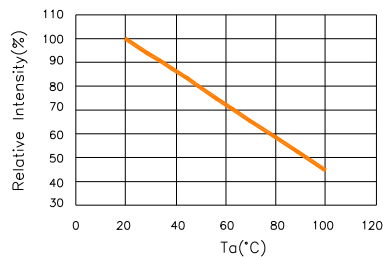

Fig.4-Relative Intensity(@20mA)VS. Ambient Temperature

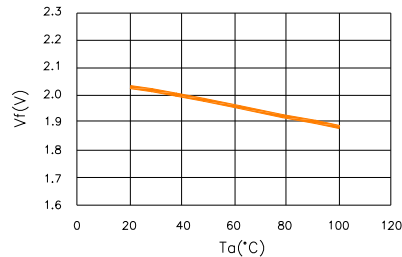

Fig.5-Forward Voltage(@20mA)VS. Ambient Temperature

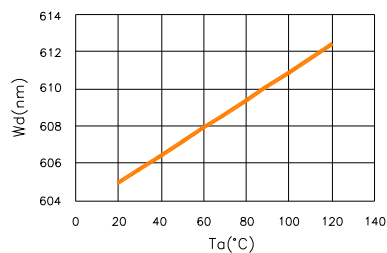

Fig.6-Dominant Wavelength(@20mA)
VS. Ambient Temperature

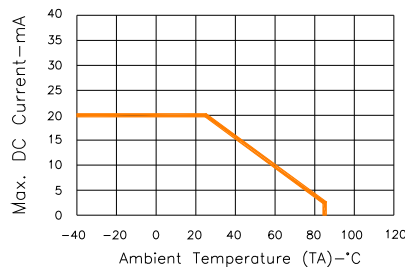

Fig.7-Max. Allowable DC Current
VS. Ambient Temperature



Opto Plus LED Corp.

0.30" Case Mold Type LED Display

OPD-T3010LA | OPD-T3011LA

● RECOMMEND SOLDERING PROFILE

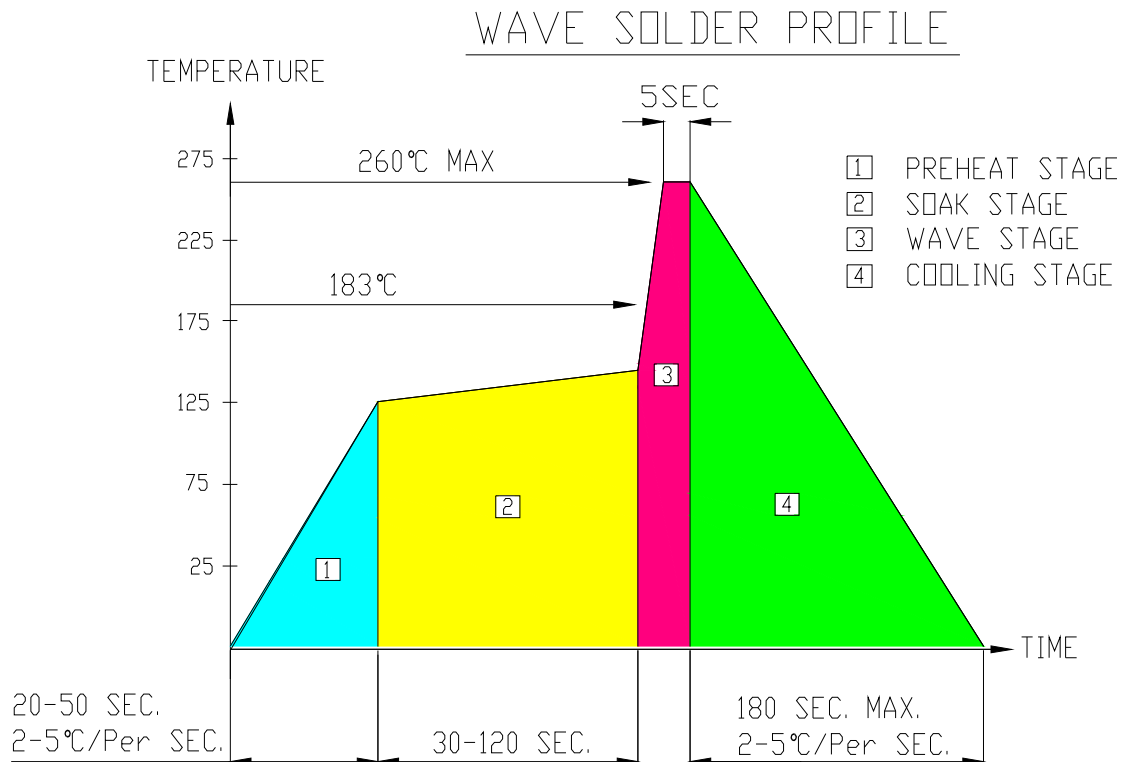

● Note:

- Recommend pre-heat temperature of 105°C or less (as measured with a thermocouple attached to the LED pins) prior to immersion in the solder wave with a maximum solder bath temperature of 260°C
- Peak wave soldering temperature between 245°C ~ 225°C for 3 sec (5 sec max)
- No more than one wave soldering pass

● SOLDERING IRON

Basic spec is ≤ 4 sec when 260°C. If temperature is higher, time should be shorter (+10°C → 1 sec). Power dissipation of Iron should be smaller than 15W, and temperature should be controllable. Surface temperature of the device should be under 230°C.

● REWORK

Customer must finish rework within ≤ 3 sec under 350°C.
The head of soldering iron cannot touch copper foil.