



www.opledtw.com

Opto Plus LED Corp.
0.36" Case Mold Type LED Display
OPD-D3610LR | OPD-D3611LR

● **EDIT HISTORY**

Version A: Nov. 04, 2020

Preliminary Spec.



www.opledtw.com

Opto Plus LED Corp.

0.36" Case Mold Type LED Display

OPD-D3610LR | OPD-D3611LR

● FEATURES

- 0.36 inch (9.2 mm) Digit Height.
- Low current operation.
- Case mold type.
- RoHS compliant, Pb Free.

● DESCRIPTION

The device are 0.36 inch (9.2 mm) height dual digit 7-segment displays.

The device is Opto Plus LED Corp standard LED Display.

This device utilizes Super Red LED chip which are made from AlGaInP on a transparent GaAs substrate.

The device has face and segment option, please refer to **PRODUCT APPEARANCE**.

● DEVICE

PART NO.	DESCRIPTION
OPD-D3610LR-GW	Common Anode Gray face White segment
OPD-D3611LR-GW	Common Cathode Gray face White segment
OPD-D3610LR-BW	Common Anode Black face White segment
OPD-D3611LR-BW	Common Cathode Black face White segment

RoHS Compliance



Pb Free.



MECHANICAL DIMENSIONS

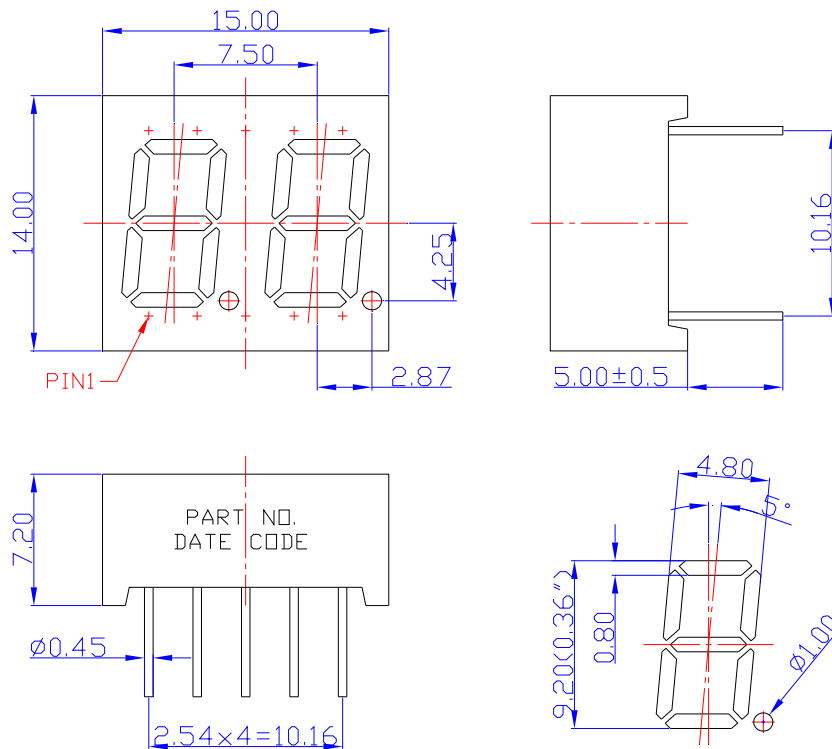

NOTES: Dimension is in millimeters. Tolerance is ± 0.25 mm unless otherwise noted.

TYPICAL INTERNAL EQUIVALENT CIRCUIT

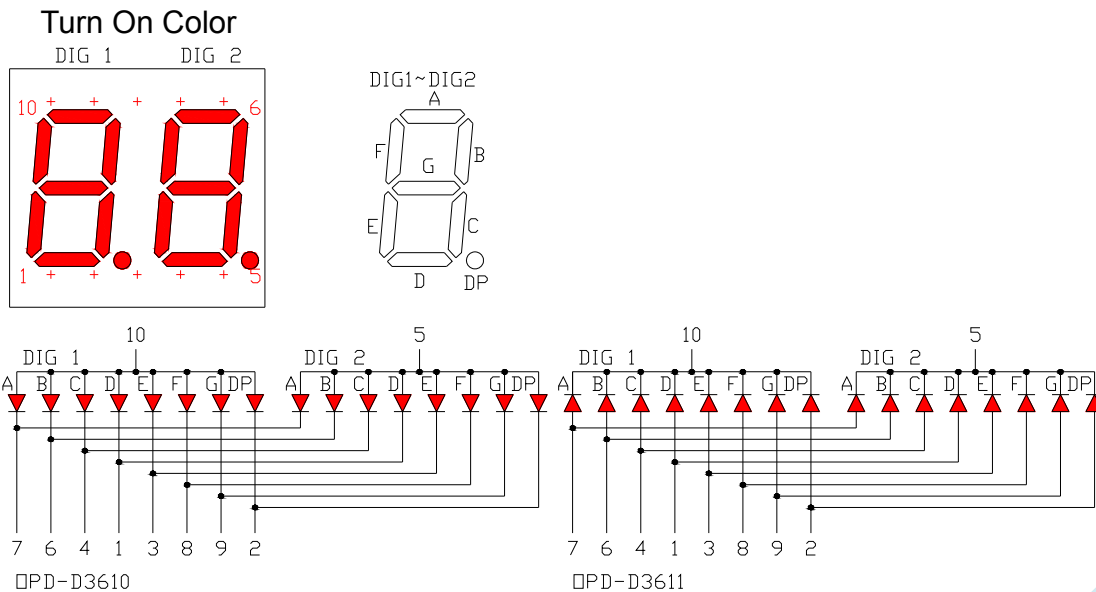

※EMITTED COLOR : SUPER RED



Opto Plus LED Corp.

0.36" Case Mold Type LED Display

OPD-D3610LR | OPD-D3611LR

● **LR: SUPER RED (AlGaInP/GaAs)**
ABSOLUTE MAXIMUM RATING AT Ta=25°C

Parameter	Symbol	Maximum Rating	Unit
Power dissipation	P_{AD}	48	mW
Continuous forward current	I_{AF}	20	mA
Peak current (duty cycle 1/10, 1kHz)	I_{PF}	40	mA
Reverse voltage	V_R	5	V
Operating temperature	T_{OPR}	-40 to +85	°C
Storage temperature	T_{STG}	-40 to +85	°C

ELECTRICAL - OPTICAL CHARACTERISTICS AT Ta=25°C

Characteristic	Symbol	Condition	Min.	Type.	Max.	Unit
Forward Voltage	V_F	$I_F = 20\text{mA}$	-	2.1	2.4	V
Reverse Current	I_R	$V_R = 5\text{V}$	-	-	10	μA
Peak Wavelength	λ_P	$I_F = 20\text{mA}$	-	650	-	nm
Dominant Wavelength	λ_D	$I_F = 20\text{mA}$	635	639	648	nm
Luminous Intensity	I_V	$I_F = 20\text{mA}$	-	15	-	mcd
Spectral Line Half-Bandwidth	$\Delta\lambda$	$I_F = 20\text{mA}$	-	20	-	nm



Opto Plus LED Corp.

0.36" Case Mold Type LED Display

OPD-D3610LR | OPD-D3611LR

● PRODUCT APPEARANCE

The most common reflector color and segment color are show in below diagram.

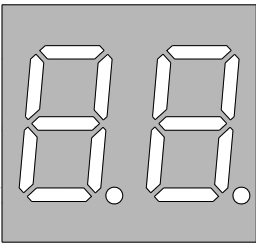
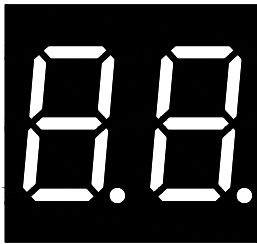
-GW	-BW
	
※ REFLECTOR COLOR: Gray ※ SEGMENT COLOR: White	※ REFLECTOR COLOR: Black ※ SEGMENT COLOR: White

Opto Plus can customize reflector and segment colors by customer's request. If you have these request please visit www.opledtw.com or contact sales@opledtw.com for more **Standard Product Customization** information.

Part NO. related to reflector and segment colors show as table below.

PART NO.	DESCRIPTION
OPD-D3610LR-GW	Common Anode Gray face White segment
OPD-D3611LR-GW	Common Cathode Gray face White segment
OPD-D3610LR-BW	Common Anode Black face White segment
OPD-D3611LR-BW	Common Cathode Black face White segment



Opto Plus LED Corp.

0.36" Case Mold Type LED Display

OPD-D3610LR | OPD-D3611LR

● LR: SUPER RED (AlGaInP/GaAs) CURVE

Typical Electro-optical Characteristic Curves
(25 °C Free Air Temperature Unless Otherwise Specified)

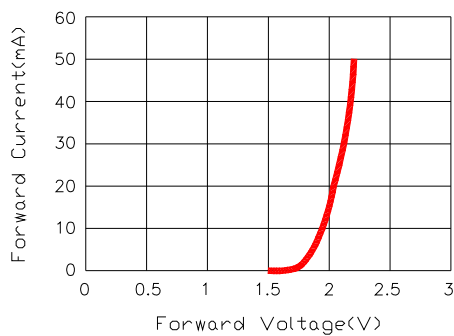

Fig.1 FORWARD CURRENT VS. FORWARD VOLTAGE

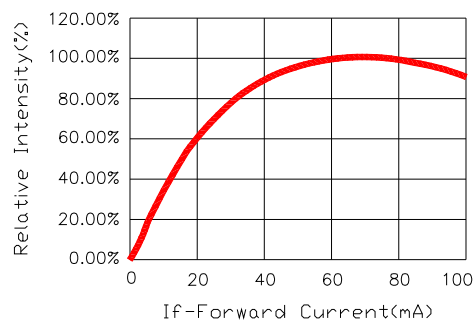

Fig.2 RELATIVE INTENSITY VS. FORWARD CURRENT

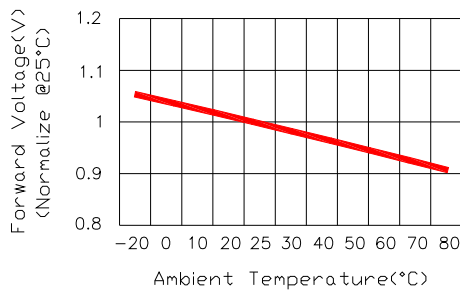

Fig.3 FORWARD VOLTAGE VS. TEMPERATURE

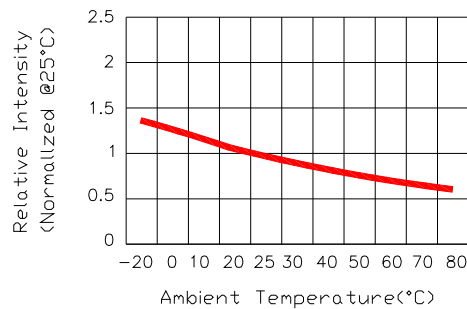

Fig.4 RELATIVE INTENSITY VS. TEMPERATURE

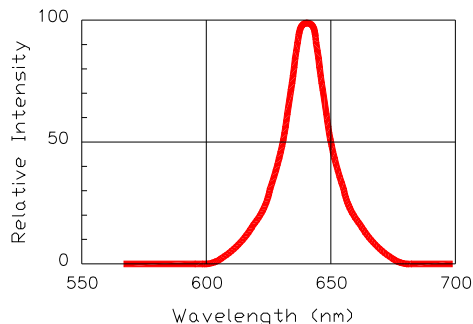

Fig.5 RELATIVE INTENSITY VS. WAVELENGTH

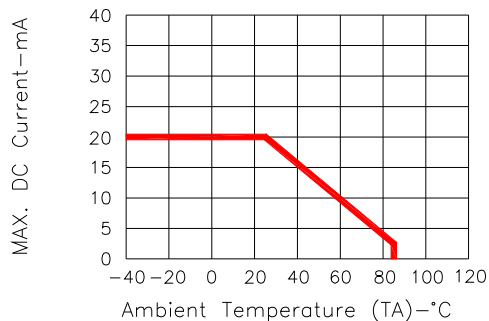

Fig.6 MAX. ALLOWABLE DC CURRENT VS. AMBIENT TEMPERATURE



Opto Plus LED Corp.

0.36" Case Mold Type LED Display

OPD-D3610LR | OPD-D3611LR

● RECOMMEND SOLDERING PROFILE

WAVE SOLDER PROFILE

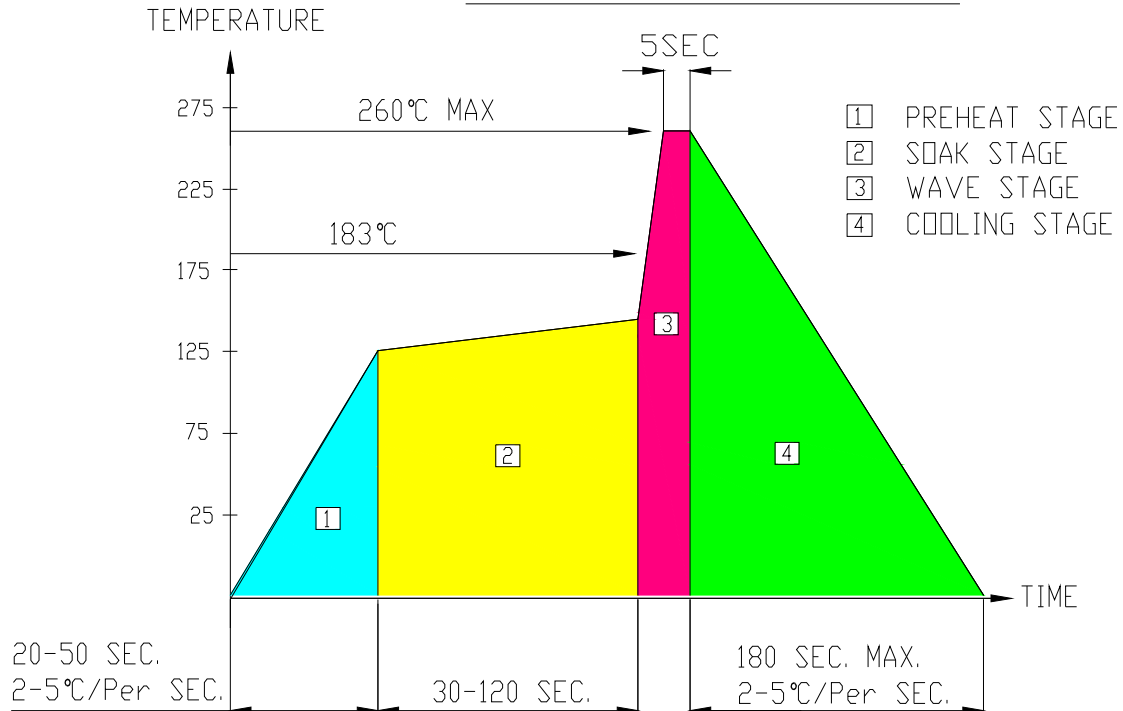

● Note:

- Recommend pre-heat temperature of 105°C or less (as measured with a thermocouple attached to the LED pins) prior to immersion in the solder wave with a maximum solder bath temperature of 260°C
- Peak wave soldering temperature between 245°C ~ 225°C for 3 sec (5 sec max)
- No more than one wave soldering pass

● SOLDERING IRON

Basic spec is ≤ 4 sec when 260°C. If temperature is higher, time should be shorter (+10°C → 1 sec). Power dissipation of Iron should be smaller than 15W, and temperature should be controllable. Surface temperature of the device should be under 230°C.

● REWORK

Customer must finish rework within ≤ 3 sec under 350°C.
The head of soldering iron cannot touch copper foil.