



[www.opledtw.com](http://www.opledtw.com)

**Opto Plus LED Corp.**  
**1.0" Case Mold Type LED Display**  
**OPD-AS10010LY | OPD-AS10011LY**

● **EDIT HISTORY**

Version A : Nov. 04, 2020

Preliminary Spec.



# Opto Plus LED Corp.

## 1.0" Case Mold Type LED Display

### OPD-AS10010LY | OPD-AS10011LY

#### ● FEATURES

- 1.00 inch (25.4 mm) Digit Height.
- Low current operation.
- Case mold type.
- RoHS compliant, Pb Free.

#### ● DESCRIPTION

The device are 1.00 inch (25.4 mm) height character alphanumeric display.

The device is Opto Plus LED Corp standard LED Display.

This device utilizes Super Bright Yellow LED chip which are made from AlGaInP on a transparent GaAs substrate.

The device has face and segment option, please refer to **PRODUCT APPEARANCE**.

#### ● DEVICE

PART NO.	DESCRIPTION
OPD-AS10010LY-GW	Common Anode   Gray face   White segment
OPD-AS10011LY-GW	Common Cathode   Gray face   White segment
OPD-AS10010LY-BW	Common Anode   Black face   White segment
OPD-AS10011LY-BW	Common Cathode   Black face   White segment

#### RoHS Compliance



#### Pb Free.





# Opto Plus LED Corp.

## 1.0" Case Mold Type LED Display

### OPD-AS10010LY | OPD-AS10011LY

#### ● MECHANICAL DIMENSIONS

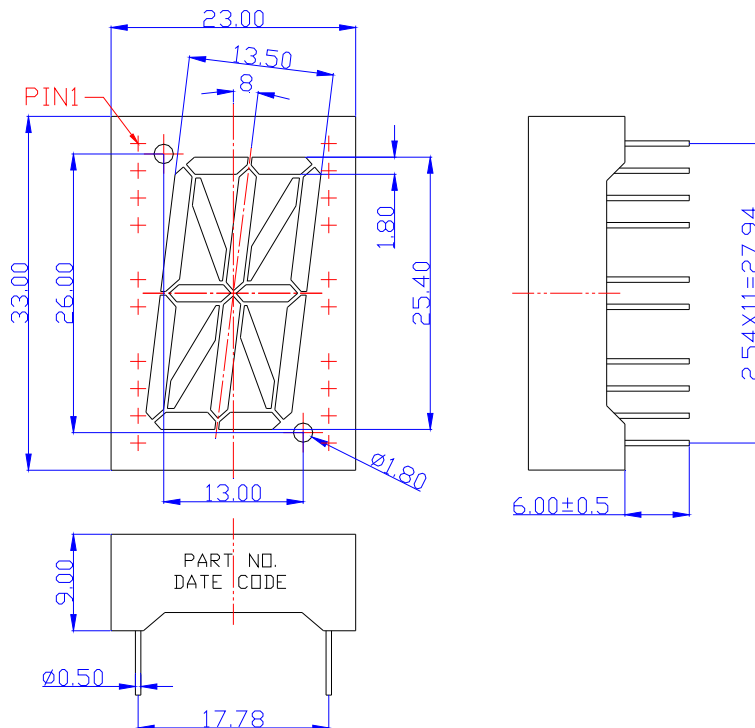

NOTES: Dimension is in millimeters. Tolerance is  $\pm 0.25$  mm unless otherwise noted.

#### ● TYPICAL INTERNAL EQUIVALENT CIRCUIT

Turn On Color

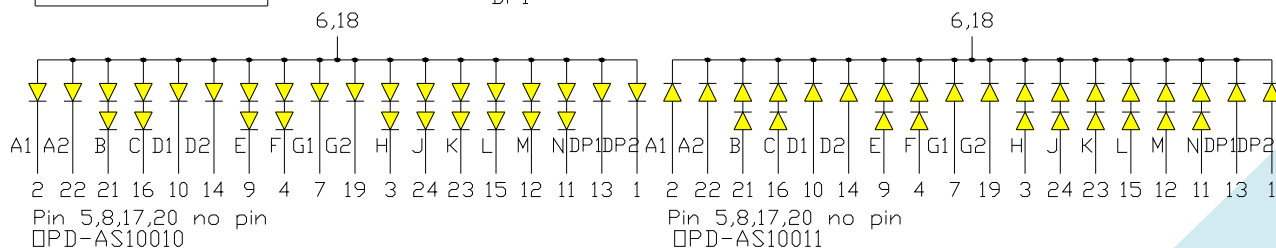
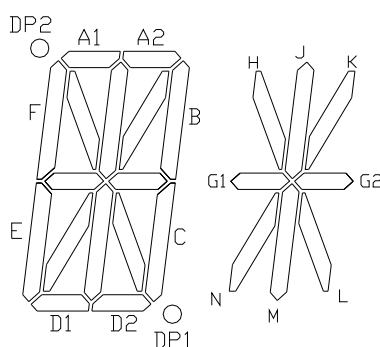
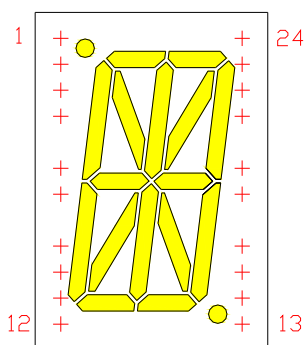

※EMITTED COLOR : SUPER BRIGHT YELLOW



**Opto Plus LED Corp.**  
**1.0" Case Mold Type LED Display**  
**OPD-AS10010LY | OPD-AS10011LY**

● **LY: SUPER BRIGHT YELLOW (AlGaInP/GaAs)**

ABSOLUTE MAXIMUM RATING AT Ta=25°C

Parameter	Symbol	Maximum Rating	Unit
Power dissipation per dice	$P_{AD}$	48	mW
Continuous forward current per dice	$I_{AF}$	20	mA
Peak current (duty cycle 1/10, 1kHz)	$I_{PF}$	40	mA
Reverse voltage	$V_R$	5	V
Operating temperature	$T_{OPR}$	-40 to +85	°C
Storage temperature	$T_{STG}$	-40 to +85	°C

ELECTRICAL - OPTICAL CHARACTERISTICS AT Ta=25°C

Characteristic	Symbol	Condition	Min.	Type.	Max.	Unit
Forward voltage per Segment (DP)	$V_F$	$I_F = 20\text{mA}$	-	4.2 (2.1)	4.8 (2.4)	V
Reverse Current	$I_R$	$V_R = 5\text{V}$	-	-	10	$\mu\text{A}$
Peak Wavelength	$\lambda_P$	$I_F = 20\text{mA}$	-	593	-	nm
Dominant Wavelength	$\lambda_D$	$I_F = 20\text{mA}$	585	590	595	nm
Luminous Intensity	$I_V$	$I_F = 20\text{mA}$	-	100	-	mcd
Spectral Line Half-Bandwidth	$\Delta\lambda$	$I_F = 20\text{mA}$	-	20	-	nm



# Opto Plus LED Corp.

## 1.0" Case Mold Type LED Display

### OPD-AS10010LY | OPD-AS10011LY

#### ● PRODUCT APPEARANCE

The most common reflector color and segment color are show in below diagram.

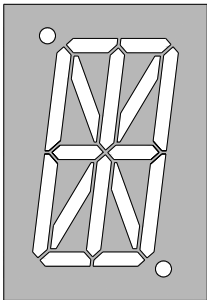
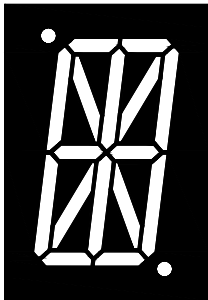
-GW	-BW
	
※ REFLECTOR COLOR: Gray ※ SEGMENT COLOR: White	※ REFLECTOR COLOR: Black ※ SEGMENT COLOR: White

Opto Plus can customize reflector and segment colors by customer's request. If you have these request please visit [www.opledtw.com](http://www.opledtw.com) or contact [sales@opledtw.com](mailto:sales@opledtw.com) for more **Standard Product Customization** information.

Part NO. related to reflector and segment colors show as table below.

PART NO.	DESCRIPTION
OPD-AS10010LY-GW	Common Anode   Gray face   White segment
OPD-AS10011LY-GW	Common Cathode   Gray face   White segment
OPD-AS10010LY-BW	Common Anode   Black face   White segment
OPD-AS10011LY-BW	Common Cathode   Black face   White segment



# Opto Plus LED Corp.

## 1.0" Case Mold Type LED Display

### OPD-AS10010LY | OPD-AS10011LY

#### ● LY: SUPER BRIGHT YELLOW (AlGaInP/GaAs) CURVE

Typical Electro-optical Characteristic Curves  
(25 °C Free Air Temperature Unless Otherwise Specified)

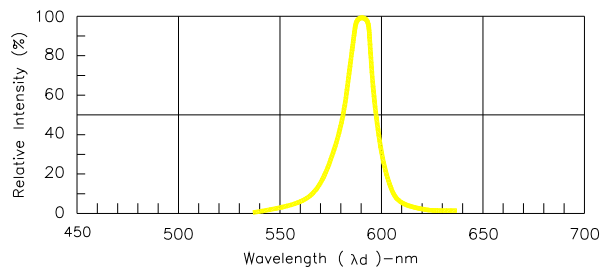

Fig.1-Relative Intensity VS. Wavelength

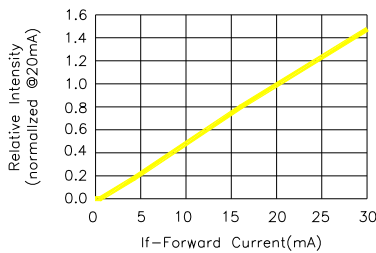

Fig.2-Relative Luminous Intensity vs. Forward Current

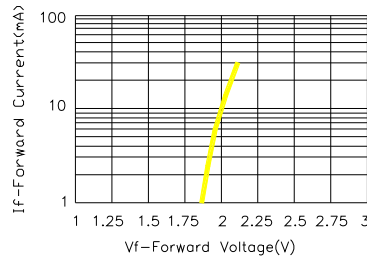

Fig.3-Forward Current vs. Forward Voltage

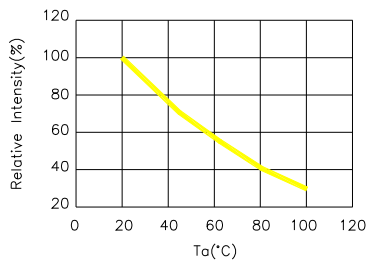

Fig.4-Relative Intensity(@20mA) vs. Ambient Temperature

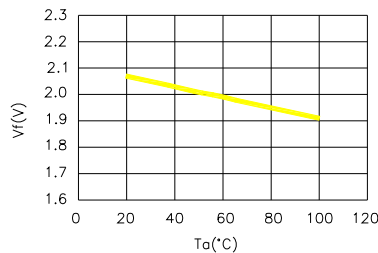

Fig.5-Forward Voltage(@20mA) vs. Ambient Temperature

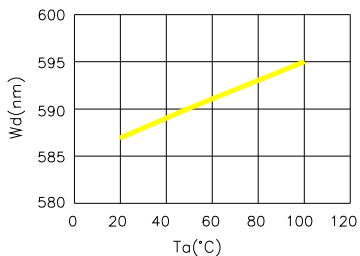

Fig.6-Dominant Wavelength(@20mA) VS. Ambient Temperature

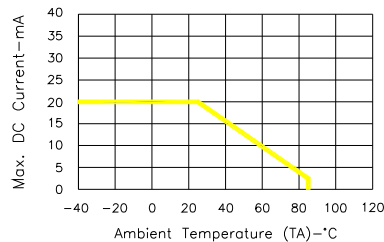

Fig.7-Max. Allowable DC Current VS. Ambient Temperature



# Opto Plus LED Corp.

## 1.0" Case Mold Type LED Display

### OPD-AS10010LY | OPD-AS10011LY

#### ● RECOMMEND SOLDERING PROFILE



#### ● Note:

- Recommend pre-heat temperature of 105°C or less (as measured with a thermocouple attached to the LED pins) prior to immersion in the solder wave with a maximum solder bath temperature of 260°C
- Peak wave soldering temperature between 245°C ~ 225°C for 3 sec (5 sec max)
- No more than one wave soldering pass

#### ● SOLDERING IRON

Basic spec is  $\leq 4$  sec when 260°C. If temperature is higher, time should be shorter (+10°C → 1 sec). Power dissipation of Iron should be smaller than 15W, and temperature should be controllable. Surface temperature of the device should be under 230°C.

#### ● REWORK

Customer must finish rework within  $\leq 3$  sec under 350°C.  
The head of soldering iron cannot touch copper foil.