



**Opto Plus LED Corp.**  
**0.28" SMD Type LED Display**  
**OPS-T2812SE | OPS-T2811SE**

● **EDIT HISTORY**

Version A: Nov. 16, 2020

Preliminary Spec.



# Opto Plus LED Corp.

## 0.28" SMD Type LED Display

### OPS-T2812SE | OPS-T2811SE

#### ● FEATURES

- 0.28 inch (7.00 mm) Digit Height.
- SMD type.
- Low current operation.
- RoHS Compliant, Pb Free.

#### ● DESCRIPTION

The device are 0.28 inch (7.00 mm) height triple digit 7-segment displays.

The device is Opto Plus LED Corp standard LED Display.

This device utilizes Super Bright Red LED chip which are made from AlGaInP

On a transparent GaAs, substrate.

The device has face and segment option, please refer to **PRODUCT APPEARANCE**.

#### ● DEVICE

PART NO.	DESCRIPTION
OPS-T2812SE-GW	Common Anode   Gray face   White segment
OPS-T2811SE-GW	Common Cathode   Gray face   White segment
OPS-T2812SE-BW	Common Anode   Black face   White segment
OPS-T2811SE-BW	Common Cathode   Black face   White segment

**RoHS Compliance**



**Pb Free.**



### ● MECHANICAL DIMENSIONS

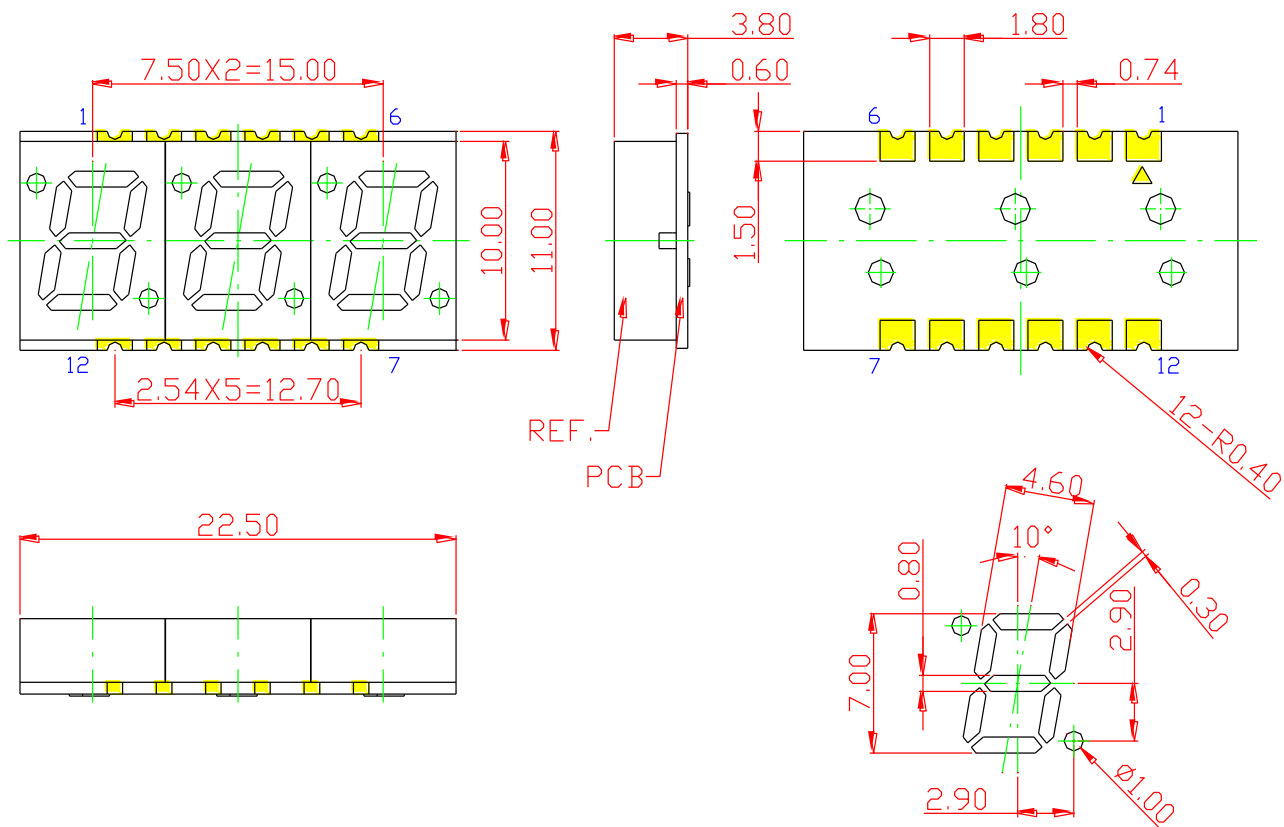

NOTES: All dimensions are in millimeters. Tolerances are  $\pm 0.25$  mm unless otherwise noted.

#### ● TYPICAL INTERNAL EQUIVALENT CIRCUIT

Turn On Color

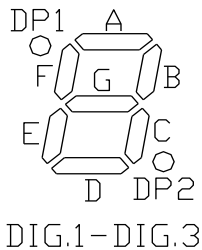
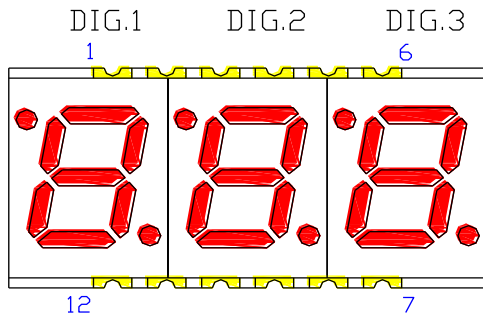

Recommended Soldering Pattern

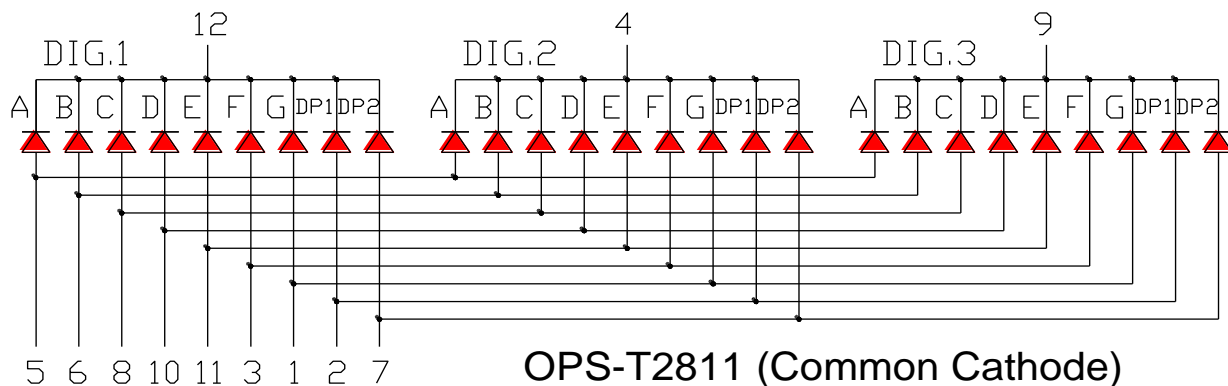
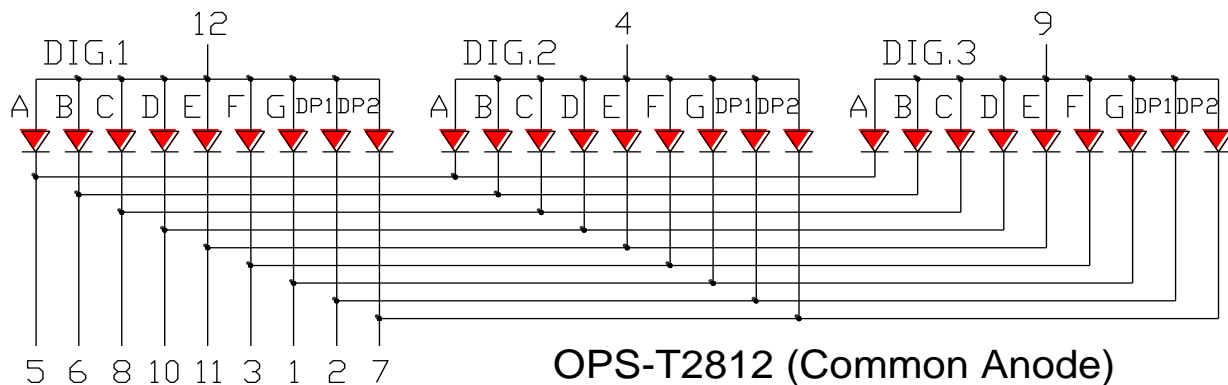
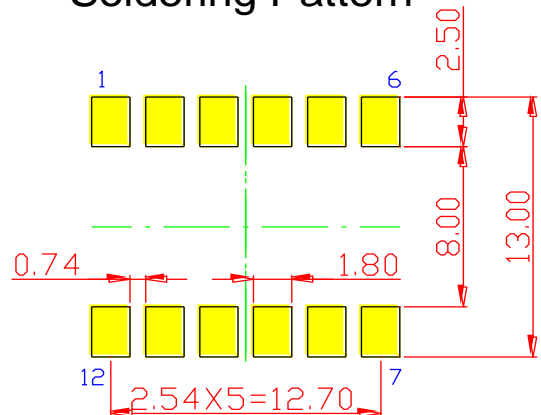

※EMITTED COLOR : SUPER BRIGHT RED



# Opto Plus LED Corp.

## 0.28" SMD Type LED Display

### OPS-T2812SE | OPS-T2811SE

#### ● PRODUCT APPEARANCE

The most common reflector color and segment color are show in below diagram.

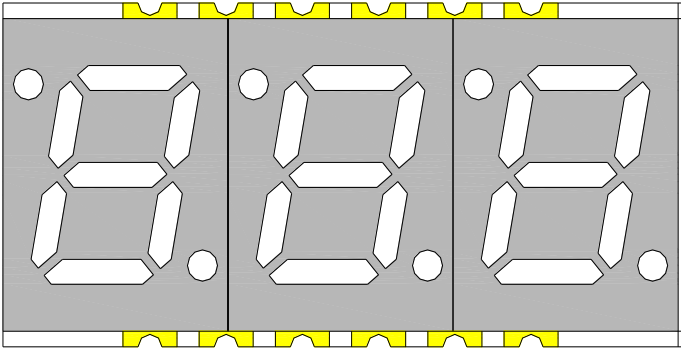
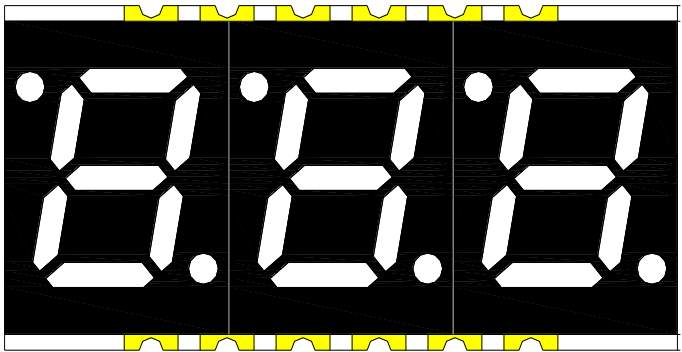
-GW	-BW
	
※ REFLECTOR COLOR: Gray ※ SEGMENT COLOR: White	※ REFLECTOR COLOR: Black ※ SEGMENT COLOR: White

Opto Plus can customize reflector and segment colors by customer's request. If you have these request please visit [www.opledtw.com](http://www.opledtw.com) or contact [sales@opledtw.com](mailto:sales@opledtw.com) for more **Standard Product Customization** information.

Part NO. related to reflector and segment colors show as table below.

PART NO.	DESCRIPTION
OPS-T2812SE-GW	Common Anode   Gray face   White segment
OPS-T2811SE-GW	Common Cathode   Gray face   White segment
OPS-T2812SE-BW	Common Anode   Black face   White segment
OPS-T2811SE-BW	Common Cathode   Black face   White segment



# Opto Plus LED Corp.

## 0.28" SMD Type LED Display

### OPS-T2812SE | OPS-T2811SE

#### ● SE: SUPER BRIGHT RED (AlGaInP/GaAs)

ABSOLUTE MAXIMUM RATING AT  $T_a=25^{\circ}\text{C}$

Parameter	Symbol	Maximum Rating	Unit
Power dissipation	$P_{AD}$	48	mW
Continuous forward current	$I_{AF}$	20	mA
Peak current (duty cycle 1/10, 1kHz)	$I_{PF}$	40	mA
Reverse voltage	$V_R$	5	V
Operating temperature	$T_{OPR}$	-40 to +105	$^{\circ}\text{C}$
Storage temperature	$T_{STG}$	-40 to +105	$^{\circ}\text{C}$

#### ELECTRICAL - OPTICAL CHARACTERISTICS AT $T_a=25^{\circ}\text{C}$

Characteristic	Symbol	Condition	Min.	Type.	Max.	Unit
Forward Voltage, (Per Dice)	$V_F$	$I_F=20\text{mA}$	-	2.1	2.4	V
Reverse Current, (Per Dice)	$I_R$	$V_R=5\text{V}$	-	-	10	$\mu\text{A}$
Peak Wavelength	$\lambda_P$	$I_F=20\text{mA}$	-	632	-	nm
Dominant Wavelength	$\lambda_D$	$I_F=20\text{mA}$	619	-	629	nm
Luminous Intensity	$I_v$	$I_F=20\text{mA}$	10	32.5	55	mcd
Spectral Line Half-Bandwidth	$\Delta\lambda$	$I_F=20\text{mA}$	-	20	-	nm



**Opto Plus LED Corp.**  
**0.28” SMD Type LED Display**  
**OPS-T2812SE | OPS-T2811SE**

● **SE: BIN GRADE (Unit : mcd) 20mA**

Super Bright Red	K	L	M
	10.0 – 25.0	25.1 - 40.0	40.1 - 55.0

● **SE: HUE GRADE ( $\lambda_D$  : nm)**

1	2	3
619.0 – 622.0	622.1 – 626.0	626.1 – 629.0

● **AVAILABLE BIN / HUE TABLE**

K1	K2	K3
L1	L2	L3
M1	M2	M3



# Opto Plus LED Corp.

## 0.28" SMD Type LED Display

### OPS-T2812SE | OPS-T2811SE

#### ● SE: SUPER BRIGHT RED (AlGaInP/GaAs) CURVE

Typical Electro-optical Characteristic Curves  
(25 °C Free Air Temperature Unless Otherwise Specified)

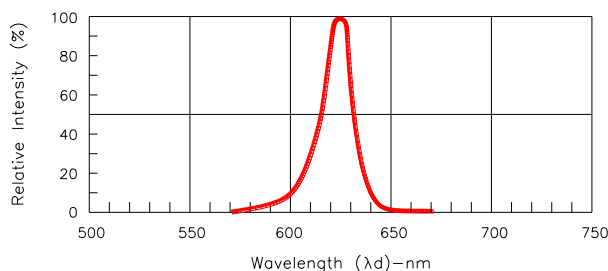

Fig.1-Relative Intensity VS. Wavelength

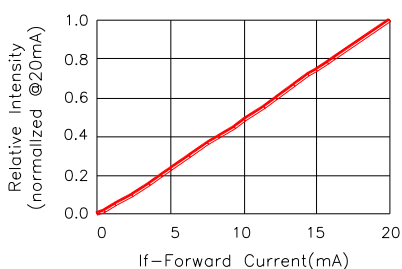

Fig.2-Relative Luminous Intensity vs. Forward Current

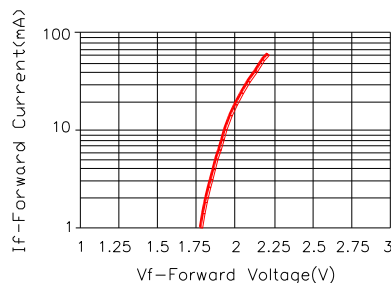

Fig.3-Forward Current vs. Forward Voltage

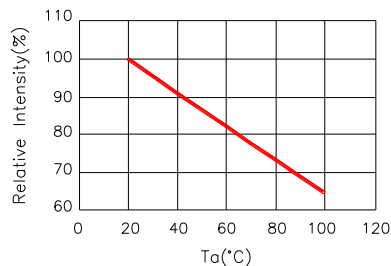

Fig.4-Relative Intensity(@20mA) vs. Ambient Temperature

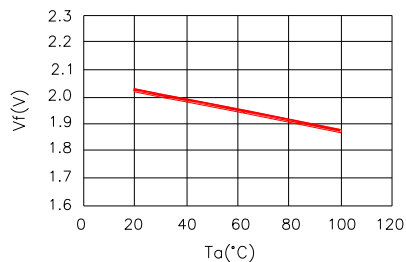

Fig.5-Forward Voltage(@20mA) vs. Ambient Temperature

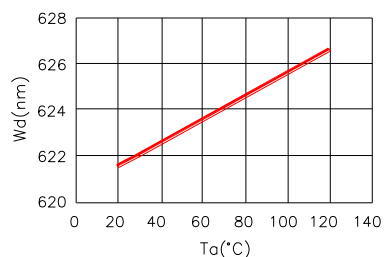

Fig.6-Dominant Wavelength(@20mA) VS. Ambient Temperature

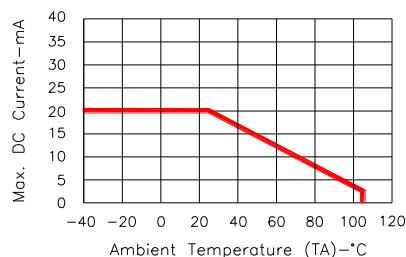

Fig.7-Max. Allowable DC Current VS. Ambient Temperature



## ● SMT REFLOW SOLDERING INSTRUCTIONS

SMT Soldering Profile

Pb free reflow soldering Profile

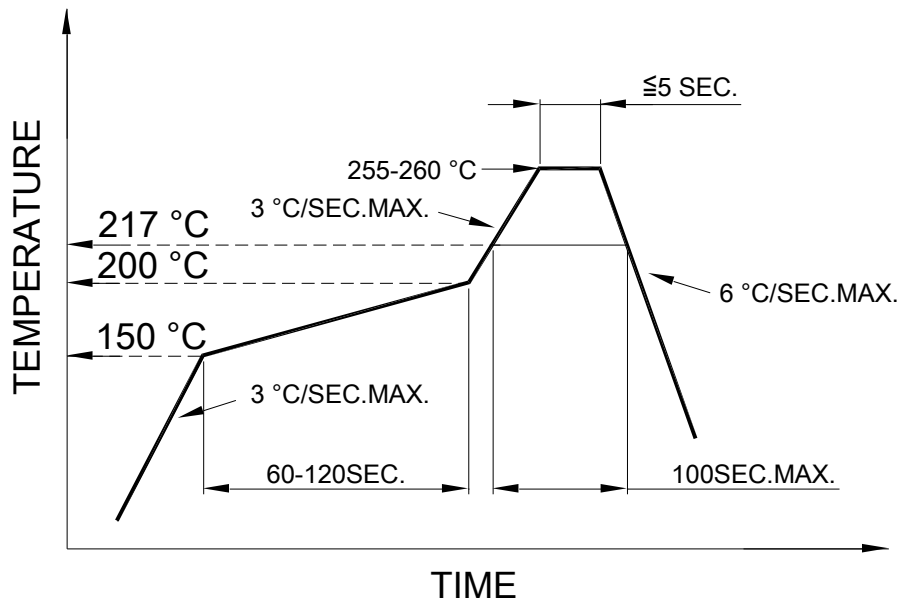

- We recommend the reflow temperature 245°C (+/- 5°C).  
The maximum soldering temperature should be limited to 260°C.
- Number of reflow process shall be 2 times or less.

## ● SOLDERING IRON

Basic spec is  $\leq 4$  sec when 260°C. If temperature is higher, time should be shorter (+10°C → 1 sec). Power dissipation of Iron should be smaller than 15W, and temperature should be controllable. Surface temperature of the device should be under 230°C.

## ● REWORK

- Customer must finish rework within 3 sec. under 350°C.
- The head of soldering iron cannot touch copper foil.

### ● REEL DIMENSIONS

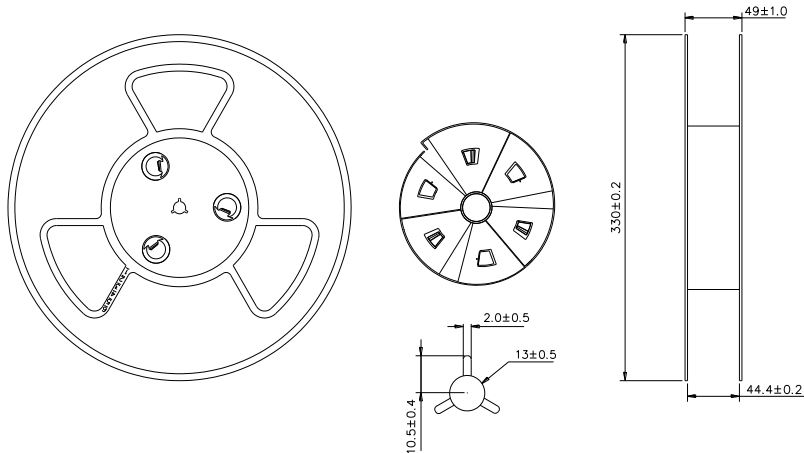

### ● PACKING & LABEL SPECIFICATIONS

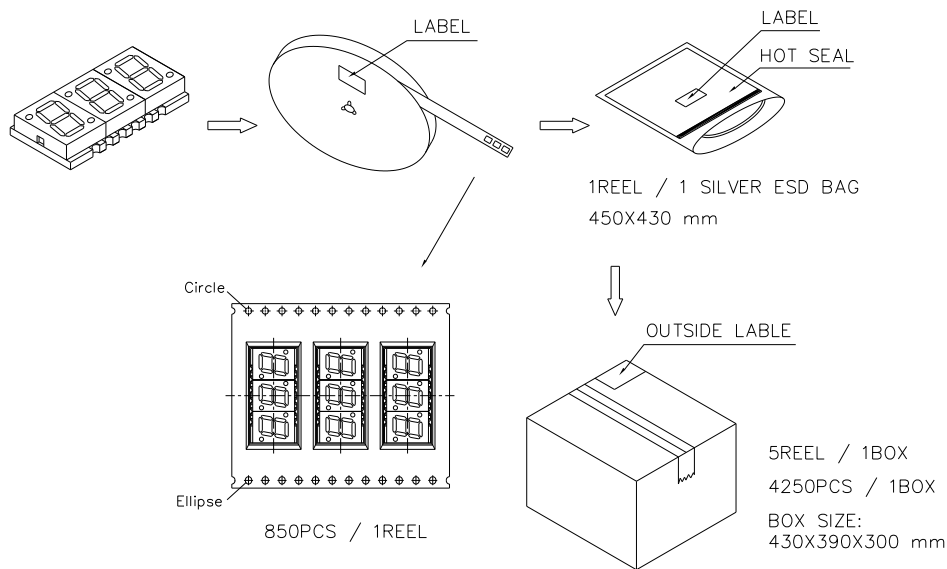

### ● STORAGE CONDITION

In factory original sealed bag package

TEMPERATURE CONDITION	HUMIDITY CONDITION
5°C ~ 30°C	Below 60%RH

After opened and not in factory original sealed bag package

TEMPERATURE CONDITION	HUMIDITY CONDITION	STORAGE TIME
5°C ~ 30°C	Below 60%RH	Within 4 weeks (MSL as level 2a)